

mbk

STRONG  
CONNECTIONS



**reinforcement solutions**



# CONTENTS



## mbk

|          |       |
|----------|-------|
| Company  | 04/05 |
| Services | 06/07 |

## Mesh welding machines

|   |       |
|---|-------|
| MSM-L/S (ladders, small format and strip meshes)                      | 08/09 |
| MSM-B (reinforcement meshes, flat elements, frame profiles and boxes) | 10/11 |
| MSM-M (fully automated production of CAD-based reinforcement meshes)  | 12/13 |
| MSM-Automation (automation solutions for mesh welding machines)       | 14/15 |

## Lattice girder and truss welding machines

|                               |       |
|-------------------------------|-------|
| GTM (precast lattice girders) | 16/17 |
|-------------------------------|-------|

## Wire straightening and cutting machines

|   |       |
|---|-------|
| DRA (straightening, cutting and bending of reinforcement wires from coil) | 18/19 |
|---|-------|

## Cage welding machines for driven and bored piles, columns and beams

|  |       |
|--|-------|
| ASM (flexible production of reinforcement cages)                   | 20/21 |
| LSM (round, square and conical reinforcement cages)                | 22/23 |
| KHG (cage handling device)   | 24/25 |
| RSM (round and square reinforcements cages with or without a cone) | 26/27 |
| VSM-S (round and square reinforcement cages)                       | 28/29 |
| VSM-V (square reinforcement cages)                                 | 30/31 |
| VSM-Automation (automation solutions for VSM-S and VSM-V)          | 32/33 |

## Cage welding machines for manhole and concrete pipe reinforcements

|   |       |
|---|-------|
| ISM (low budget production of reinforcement cages)        | 34/35 |
| ESM (economy production of reinforcement cages)           | 36/37 |
| BSM (high performance production of reinforcement cages)  | 38/39 |
| BSM ROR (production of round-oval-round cages)            | 40/41 |
| BSM-Automation (automation solutions for BSM and BSM-ROR) | 42/43 |

## After Sales Service / Retrofit

|       |
|-------|
| 44/45 |
|-------|

## Accessories

|       |
|-------|
| 46/47 |
|-------|



## COMPANY

### Who we are -

and where we come from

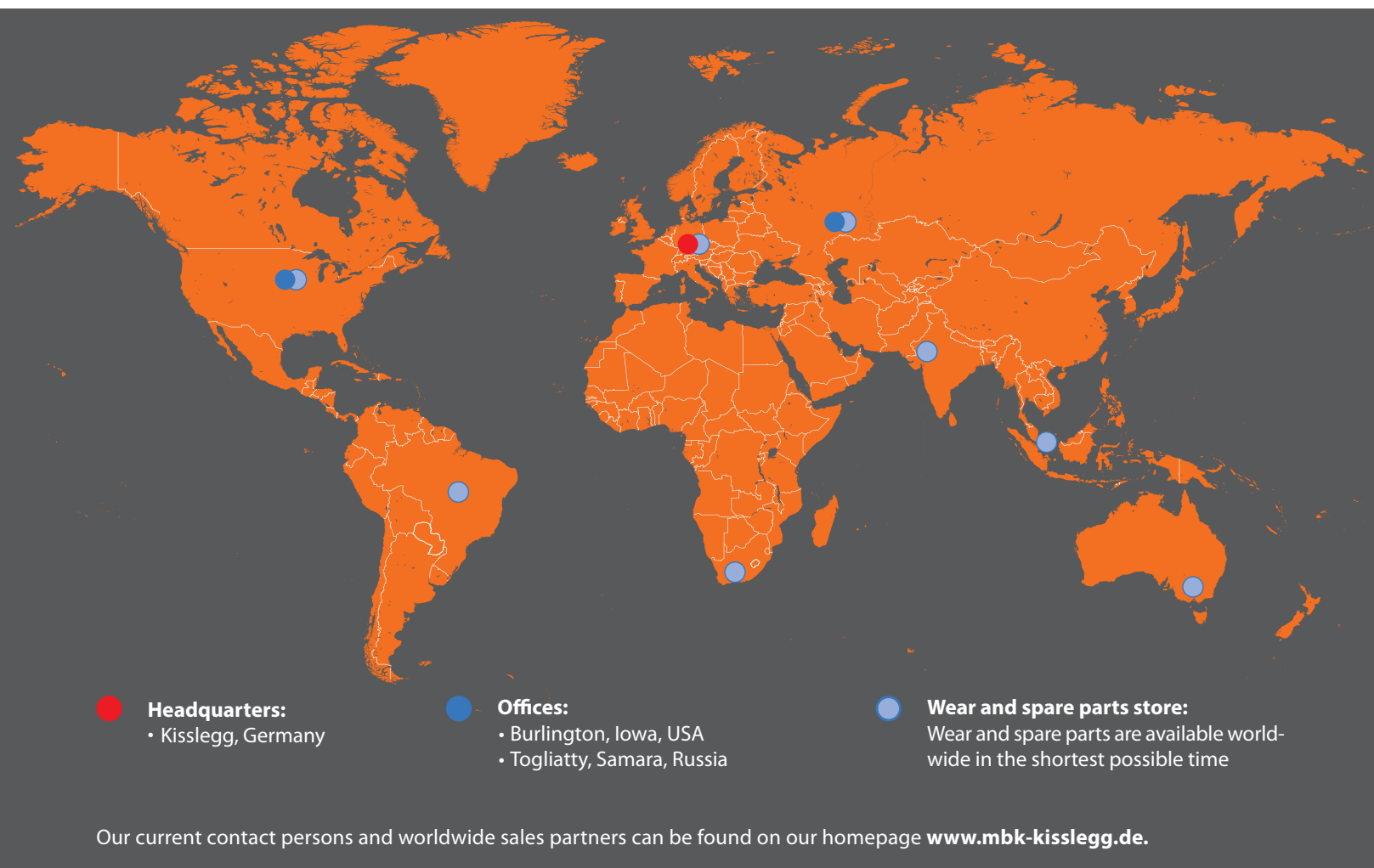

Since mbk Maschinenbau GmbH was established in 1961 by Georg Pfender, the company has developed to be one of the leading producers of cage welding machines and equipment for the building and concrete industry, by technical know-how, inventive thinking, high quality standards and a close cooperation with customers. More than 1,100 machines have meanwhile been sold to over 60 countries worldwide.

As a mid-sized family owned enterprise mbk excels by a fair partnership with customers, employees and business friends. Especially customers are treated with the highest priority. With our innovative and durable products we offer you the greatest possible benefit and investment security.

From the first planning sketch to production and installation, including after-sales service, our customers always receive competent and individual advice on standard machines, customer-specific adaptations, but also on development projects and the construction of special machines. Our modern machinery also enables us to be your reliable partner for contract manufacturing and for the production of parts and assemblies in the field of machining and steel construction.

The quality management according DIN EN ISO 9001 is an important guarantee for the quality assurance and reliability of our equipment and supports a permanent optimizing of all processes.



*The first mbk cage welding machine*



*Company founder Georg Pfender (middle)*



*mbk company site in Kisslegg*



*MSM-M mesh welding machine*

- 1961** Georg Pfender founds a machine shop
- 1968** Sale of the first reinforcement welding machine
- 1980** Move to the present location
- 1981** The first machine is delivered overseas (America)
- 1985** Albert Pfender takes over corporate management from his father Georg Pfender
- 1989** Expansion of administration and mechanical production
- 1993** Expansion of the production spectrum to machines for the production of paint rollers and brushes
- 1999** Construction of the assembly plant for machines for the production of paint rollers and brushes
- 2003** Development and extension of the production plant
- 2007** Completion and occupation of the new assembly plant with administrative offices
- 2009** Establishment of the subsidiary mbk Sales & Service Inc. in the US
- 2011** Mario Pfender joins the company and is appointed as an additional Managing Director
- 2011** 50th anniversary of the company and certification according to DIN EN ISO:9001:2008
- 2012** Establishment of the Russian subsidiary mbk Komplekt
- 2015** Sale of paint roller and brush division and begin of licensed production of the ISM-250 cage welding machine in India
- 2016** Product development of an MSM-Box-Line for the production of box culvert reinforcements and BSM-ROR (round-oval-round) for material-optimized pipe production
- 2017** Development of LSM-C for conical masts
- 2017** Mario Pfender becomes sole Managing Director
- 2018** Development of the ASM for production of bored piles with flexible amount of longitudinal wires and further development of RSM cage welding machine for driven piles
- 2019** Introduction of the flexible MSM-M mesh welding system for the precast concrete industry
- 2020** New DRA-16-M wire straightening and cutting system with bending option brought to the market



# SERVICES

What we do -  
and how we do it



Special machine type PSF for sawing and milling of concrete pipes



Highly qualified employees and up to date machining equipment for high quality products



Special machine type GSM for welding of mats for manhole bases



Special machine type VFM for vertical milling of concrete pipes

## QUALITY OFFENSIVE

### Made in Germany

mbk produces exclusively in the Kisslegg facility – concepts for individual solutions are created on a production area of around 10,000 square meters. Generous storage areas enable optimized logistics processes and fast response times.

### High quality standards

Qualified employees who receive regular continuing education and training to ensure the smooth handling of all customer orders and the highest safety standards in all production processes. In-house quality management not only guarantees the highest quality class of all the machines, but also the competent administration and logistics of all orders. mbk trains and is characterized by low labour turnover.

### Broad range of offers

Thorough analysis of our customers requirements and detailed consultation are the basis for successful cooperation. It does not matter whether it concerns new evolutions or further developments, upgrades, modifications, custom manufacture in the field of large machines, precision-engineered application equipment or tools for manual work processes.

## QUALITY OFFENSIVE

### Maximum design expertise

Sophisticated designs emerge from the most modern design and development departments. The 3D construction plans designed by highly qualified technicians and engineers are developed according to the most modern safety standards / CE and achieve 100% market maturity.

### High-tech production

Machining equipment of the latest generation is a prerequisite for the best production results. Only then is it possible to meet the strict quality standards and ensure the highest precision. The machines are operated by highly qualified employees who are able to meet the high quality standards.

### After-sales service

The service provided by mbk is far from over after delivery, installation and intensive training on the machines and systems that we produce. As part of the after-sales services the mbk service technicians can naturally also take over maintenance responsibilities. Our hotline offers fast and uncomplicated support. We offer a flawless spare parts service for our machines. The worldwide mbk sales and distribution partners make it possible.



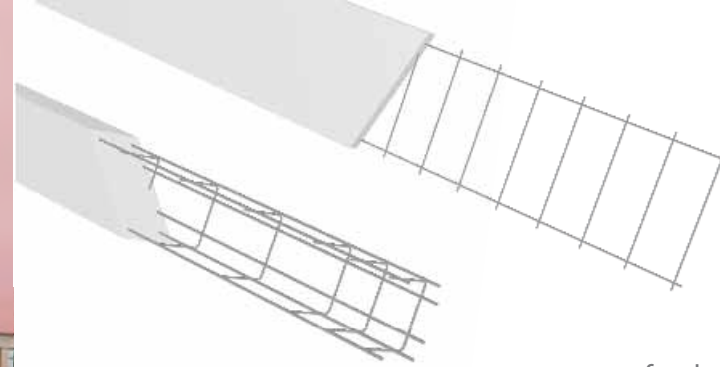

## Mesh welding machine

**MSM-L/S**

for the production of reinforcement mesh for ladders, small formats, strips, flat elements, frame profiles, L and U shaped dry cast concrete products, boxes and rectangular pipe for box culvert, U-ditch



### CHARACTERISTICS AND ACCESSORIES

- Setting of mesh and welding parameters with memorized mesh programs
- Highest flexibility due to short change over time
- Processing of cut rods for cross and longitudinal wires
- Manual longitudinal and cross wire feeding
- Easy operation by the use of a Touch-Panel and IPC/PLC-control
- Standard with 2 Phase thyristor control
- Maintenance friendly and low maintenance cost
- Only electrical or pneumatic components
- Automatic mesh ejection
- Versatile automation solutions
- LAN/WLAN connection

| Size                                       | 040  | 060/100/160          |
|--|--|----------------------|
| Version                                    | L  | S                    |
| Mesh width                                 | 50 - 400 mm  | 150 to max. 1,600 mm |
| Number of longitudinals                    | 2/4  | 3 to max. assembly   |
| Mesh length                                | 500 - 6,000 mm (larger lengths on request)                       |                      |
| Longitudinal Ø                             | 4 - 8 mm (optional 4 - 12 mm)                                    |                      |
| Cross wire Ø                               | 4 - 8 mm (optional 4 - 12 mm)                                    |                      |
| Distance between longitudinal wires (grid) | infinitely variable, min. 50 mm                                  |                      |
| Distance between cross wires               | fixed in 50 mm steps, min. 50 mm, optionally infinitely variable |                      |
| Welding capacity                           | depending on the version   |                      |

- further sizes on request





## Mesh welding machine

### MSM-B

for the production of reinforcement mesh flat elements, frame profiles, L and U shaped dry cast concrete products as well as boxes and rectangular pipe for box culvert, U-ditch



### CHARACTERISTICS AND ACCESSORIES

- Setting of mesh and welding parameters with memorized mesh programs
- Highest flexibility due to short change over time
- Processing of cut rods for cross and longitudinal wires
- Manual longitudinal and cross wire feeding
- Easy operation by the use of a Touch-Panel and IPC/PLC-control
- Standard with 2 Phase thyristor control
- Maintenance friendly and low maintenance cost
- Only electrical or pneumatic components
- Automatic mesh ejection
- Versatile automation solutions
- LAN/WLAN connection

#### Size

100/150/200/250/300

|  |  |
|--|--|
| Mesh width                                 | 400 to max. 3,000 mm   |
| Mesh length                                | 1,000 - 14,000 mm (larger lengths on request)                    |
| Longitudinal wire Ø                        | 5 - 12 mm (optional 5 - 20 mm)                                   |
| Cross wire Ø                               | 5 - 12 mm (optional 5 - 16 mm)                                   |
| Number of longitudinals                    | according to customer requirements                               |
| Distance between longitudinal wires (grid) | 50/100/150 mm  |
| Distance between cross wires               | fixed in 50 mm steps, min. 50 mm, optionally infinitely variable |
| Welding capacity                           | depending on the version up to 350 kVA                           |

- further sizes on request



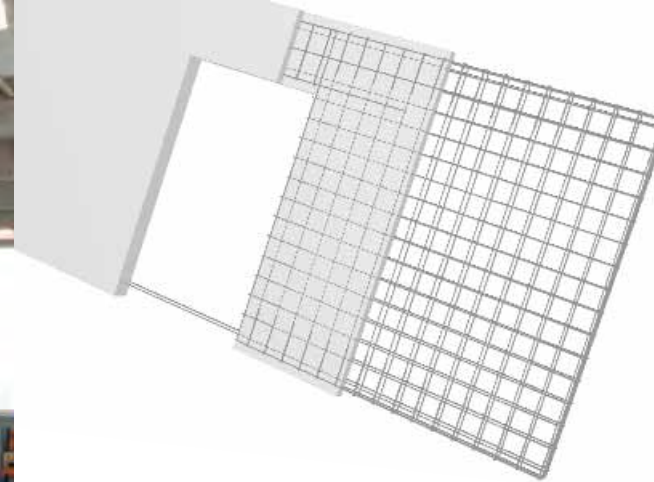

## Mesh welding machine

### MSM-M

Flexible system for fully automated production of CAD based reinforcement mesh for the production of precast concrete parts and customer-specific meshes



### CHARACTERISTICS AND ACCESSORIES

- Flexible production plant that welds reinforcing steel meshes from coils according to individual specifications
- Efficient and easy operation
- Small space requirement due to compact system
- Customized solution through modular plant system. Later expansion of system possible
- CAD based mesh welding with cut-outs, windows and doors openings
- Robust construction, low maintenance requirements
- Connection to the Unitechnik interface
- LAN/WLAN connection

#### Size

200/250/300/350/400

|                                     |  |
|-------------------------------------|--|
| Mesh width                          | 400 to max. 4,000 mm   |
| Shortest wire length                | 500 mm   |
| Mesh length                         | 1,000 - 14,000 mm (larger lengths on request)                    |
| Number of wire diameter             | 3 - 6  |
| Wire diameter                       | 5 - 16 mm (optional 5 - 20 mm) from coil                         |
| Longitudinal wire grid size         | 25 mm  |
| Distance between longitudinal wires | depending on longitudinal wire Ø 25 / 50 / 75 / 100 ... mm       |
| Distance between cross wires        | fixed in 50 mm steps, min. 50 mm, optionally infinitely variable |
| Welding capacity                    | depending on the version up to 350 kVA                           |
| Production capacity                 | depending on design and mesh coverage                            |

- further sizes on request



## MSM-Automation

Automation solutions for our mesh welding machines from simple automation accessories to fully automatic production lines with buffer solutions and connection to downstream systems



### CHARACTERISTICS AND ACCESSORIES

- Storage systems for longitudinal and cross wires for pre-assembly of the wires from coils
- Automatic feeding of the pre-assembled longitudinal wires in the machine
- Fully automatic feeding of longitudinal and cross wire from bundle or coil
- Automated wire separation systems for wire feeding from coils
- Straightening rotors for longitudinal and cross wire feeding from coils
- Connection of a multiple wire straightening and cutting plant (DRA-M) for automatic feeding of longitudinal and cross wire
- Increased performance through multi-transformer/ welding stations
- Medium-frequency welding systems (inverter technology)

Supported by:  
 Federal Ministry  
 for Economic Affairs  
 and Energy  
 on the basis of a decision  
 by the German Bundestag



### CHARACTERISTICS AND ACCESSORIES

- Various designs and solutions for mesh ejection and stacking of the mesh
- Possibilities for space-saving storage of the meshes (left/right) or by using buffer solutions
- Tilting table and vertical conveyor for the reinforcement mesh
- Fully automatic production of reinforcements for boxes (MSM-Box-Line)
- Automatic bending unit with supporting transport trolleys
- Single bender, multiple bender or complete bending machines in horizontal or vertical arrangement for integration into machines and plants
- Printer unit for labeling of the mats with text and barcode



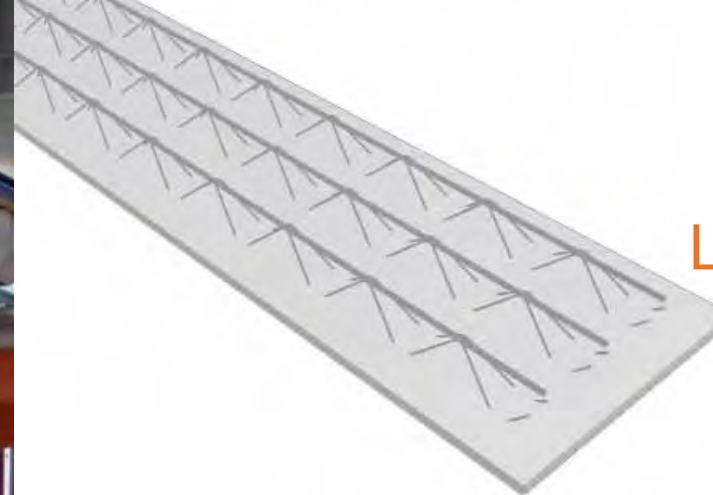

## Lattice girder welding machine

**GTM**

for the production of precast lattice girders



### CHARACTERISTICS AND ACCESSORIES

- Super flexible and quick adjustment of lattice girder heights
- Reliable and precise tools for bending of diagonal wires
- Synchronised decoilers
- Long life on welding electrodes
- Synchronized intelligent cutting of upper and lower welding nodes
- Anti-twisting technology, insures straight wires with no tension prior to welding
- High quality product, with precise welding and bending – every time!
- Fully automatic height change of the girder without any waste and a variable diagonal wire spacing from 190 to 210 mm with the GTM-040-A

| Size   | 030               | 040               | 040               |
|--|-------------------|-------------------|-------------------|
| Version  | M/V               | M/V               | A                 |
| Girder height  | 70 - 300 mm       | 80 - 400 mm       | 80 - 400 mm       |
| Girder length  | 1,200 - 14,000 mm | 1,200 - 14,000 mm | 1,900 - 14,000 mm |
| Upper wire / wires Ø                                 | 5 - 16 mm         | 5 - 16 mm         | 6 - 14 mm         |
| Lower wires Ø  | 5 - 16 mm         | 5 - 16 mm         | 6 - 14 mm         |
| Diagonal wires Ø                                     | 5 - 7 mm          | 5 - 9 mm          | 5 - 7 mm          |
| Distance between strokes                             | 200 mm            | 200 mm            | 190 - 210 mm      |
| Distance between strokes (optional) flexible between | 190 - 210 mm      | 190 - 210 mm      | -                 |
| Max. prod. Speed                                     | 15 m/min          | 15 m/min          | 15 m/min          |

- further sizes on request



# Wire straightening and cutting machine

**DRA**

for straightening, cutting and bending of reinforcement wires from coil



## CHARACTERISTICS AND ACCESSORIES

- Easy handling and operation
- The wire is straightened with straightening blocks or hyperbolic rollers
- Only electrical or pneumatic components
- Maintenance friendly
- Wrap wire decoiler for wrap wire coils up to 5,000 kg
- Quick-change system for exchanging rotors (single straightening system)
- Measuring wheel for minimum length tolerances of the straightened rods
- Flying shear
- Double bender for bending/cropping the wire ends
- LAN/WLAN connection

| Size                     | 10        | 12         | 20         | 16         | 20         |
|--------------------------|-----------|------------|------------|------------|------------|
| Version                  | C         | E          | E          | M          | M          |
| Wire diameter            | 5 - 10 mm | 4 - 12 mm  | 8 - 20 mm  | 5 - 16 mm  | 8 - 20 mm  |
| Number of rotors         | 1         | 1          | 1          | 3 - 6/8    | 3 - 6/8    |
| Production length (max.) | 3 - 4 m   | 3 - 12 m   | 3 - 12 m   | 8 - 14 m   | 8 - 14 m   |
| Feed speed (max.)        | 60 m/min. | 140 m/min. | 140 m/min. | 160 m/min. | 160 m/min. |

- further sizes on request



# Cage welding machine

ASM

for the flexible production of reinforcements for driven and bored piles, columns and beams

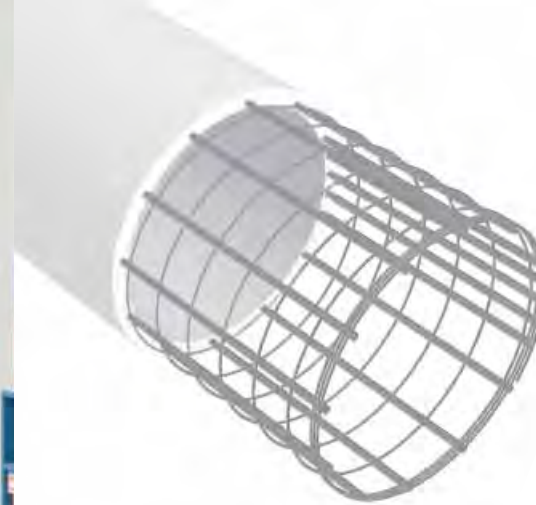

## CHARACTERISTICS AND ACCESSORIES

- Touch screen with colour screen
- Straightening unit for wrap wire
- Different welding processes possible
- Hydraulic cage support
- Setting of cages and welding parameters with memorized cage programs
- Wrap wire decoilers with or without drive
- Different longitudinal wire diameters and asynchronous divisions in one cage
- LAN/WLAN connection
- Manual welding by hand
- Inert gas shielded arc welding single and multiple
- Resistance welding
- DualWeld Option (resistance and arc welding, patented)

| Size  | 150   | 210  |
|---|---|--|
| Version                                       | R/S   | R/S  |
| Cage diameter (outer) with resistance welding | min. 236 - 274 mm<br>max. 1,536 - 1,574 mm<br>depending on the number of longitudinal wires and wire combinations | min. 500 - 546 mm<br>max. 1,954 - 2,000 mm |
| Cage diameter (outer) with arc welding        | min. 500 - 538 mm<br>max. 1,962 - 2,000 mm<br>depending on the number of longitudinal wires and wire combinations | min. 500 - 546 mm<br>max. 2,460 - 2,500 mm |
| Longitudinal wire Ø                           | 12 - 25 mm (optional 12 - 32 mm)  | 12 - 25 mm (optional 12 - 40 mm)           |
| Wrap wire Ø                                   | 6 - 12 mm (optional 6 - 16 mm)  | 6 - 12 mm (optional 6 - 16 mm)             |
| Number of longitudinals                       | Number of longitudinals as needed   |  |
| Cage length                                   | 3,000 - 24,000 mm (other lengths on request)  |  |
| Spacing of wrap wire                          | 20 - 350 mm (depending on cage diameter)  |  |

- further sizes on request





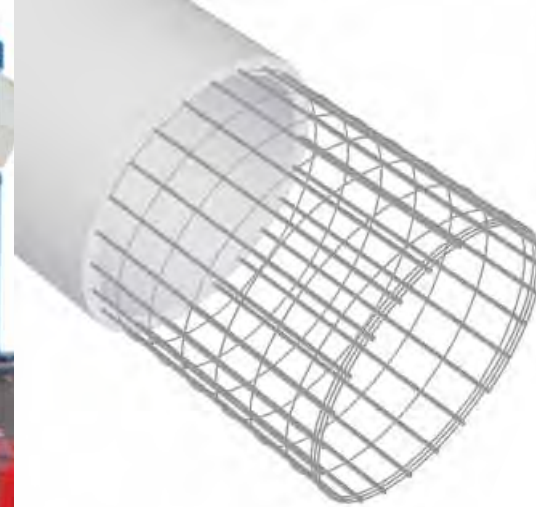
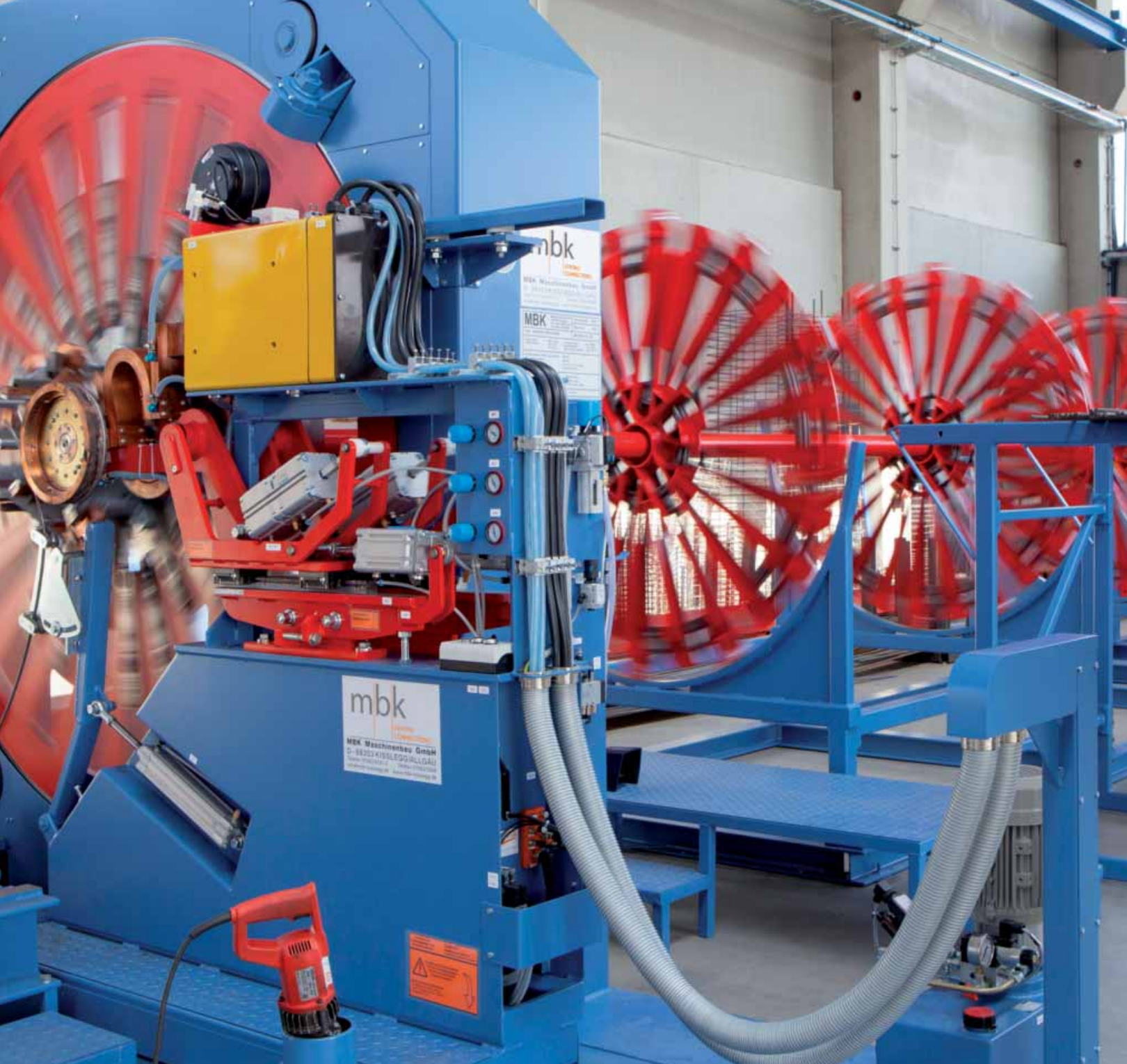

# Cage welding machine

LSM

for the production of round, square and conical reinforcement cages for masts, driven and bored piles, columns and beams



## CHARACTERISTICS AND ACCESSORIES

- No consumption of welding gas and electrodes
- Ergonomic handling at the wire and cage side
- High welding capacity and optimal welding quality due to electronical welding point control (precise power control, pressurization and duration of each welding pulse)
- Setting of cages and welding parameters with memorized cage programs
- Highest variability in the wrap wire spacing (programmable)
- Easy operation by the use of a Touch-Panel and IPC/PLC-control
- Wrap wire decoilers with and without drive
- Diameter adjustment by means of quick adjustment system (type R only)
- Electrical wire cutters
- Machine tools
- LAN/WLAN connection
- DualWeld Option (resistance and ARC welding, patented) (type R/S only)
- Max. flexibility through quick adjustment of the welding angle positions

Supported by:  
  
 on the basis of a decision  
 by the German Bundestag

**ZIM**  
 Zentrales  
 Innovationsprogramm  
 Mittelstand

| Size                                       | 084   | 150  | 150                                    | 250               |
|--|---|--|--|-------------------|
| Version*                                   | R/S   | R/S  | C                                      | C                 |
| Cage diameter (outer)                      | min. 170 x 430 mm<br>max. 866 x 910 mm<br>depending on the number of longitudinal wires and wire combinations | min. 266 x 930 mm<br>max. 1,526 x 1,570 mm   | max. 1,500 mm                          | max. 2,500 mm     |
| Flank length cage (outer, type S only)     | min. 90 x 90 - 118 x 118 mm<br>max. 613 x 613 - 641 x 641 mm  | min. 132 x 132 - 160 x 160 mm<br>max. 1,080 x 1,080 - 1,180 x 1,180 mm<br>depending on wire combinations |  |                   |
| Number of longitudinals (standard pitches) | <b>6, 8, 12, 16</b>   | <b>6, 8, 12, 16, 24</b>  | customer-specific                      | customer-specific |
| Cage length                                | 3,000 - 24,000 mm (other lengths on request)  |  |  |                   |
| Longitudinal wire Ø                        | 8 - 25 mm (optional 8 - 40 mm)  |  | 8 - 12 mm                              |                   |
| Wrap wire Ø                                | 5 - 10 mm (optional 5 - 16 mm)  |  | 5 - 8 mm                               |                   |
| Spacing of wrap wire                       | 20 - 250 mm   |  | 20 - 250 mm                            |                   |
| Welding capacity                           | depending on the version up to 250 kVA  |  | depending on the version up to 160 kVA |                   |

- further sizes on request \* Type key: R = round / S = round and square / C = round and conical **Bold** standard



## Cage handling device

**KHG**

for ergonomic handling during cage finishing

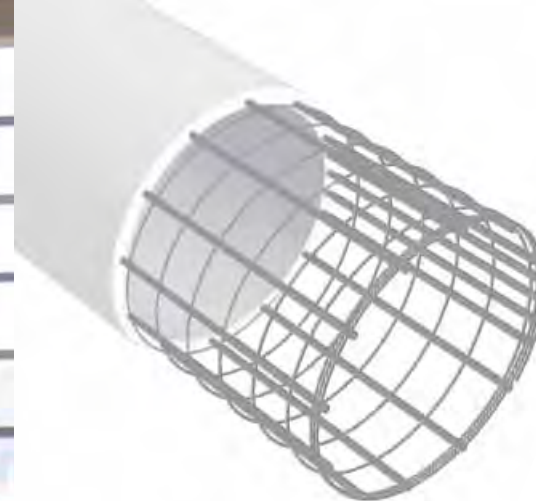

### CHARACTERISTICS AND ACCESSORIES

- Ergonomic handling during cage finishing (welding in inner rings, spacers, etc.)
- Adjustment of the reinforcement cage to the desired height
- The cages can be turned to the left and right
- Easy handling control system
- Foot switch
- Rotary drive units can be upgraded on each support
- Side guides can be upgraded on each support
- Storage compartments for welded-in parts
- Devices for mass transfer to the base frame

**Size 160**

|                |  |
|----------------|--|
| Cage diameter  | 200 - 1,600 mm   |
| Maximum load   | 1,200 kg / support (hold and turn cage)<br>300 kg / support (lift, hold and turn cage) |
| Cage length    | 3,000 - 24,000 mm  |
| Lifting height | 600 - 1,500 mm   |

- further sizes on request



## Cage welding machine

RSM

for the production of round and square reinforcements for driven and bored piles, columns and beams with or without a cone

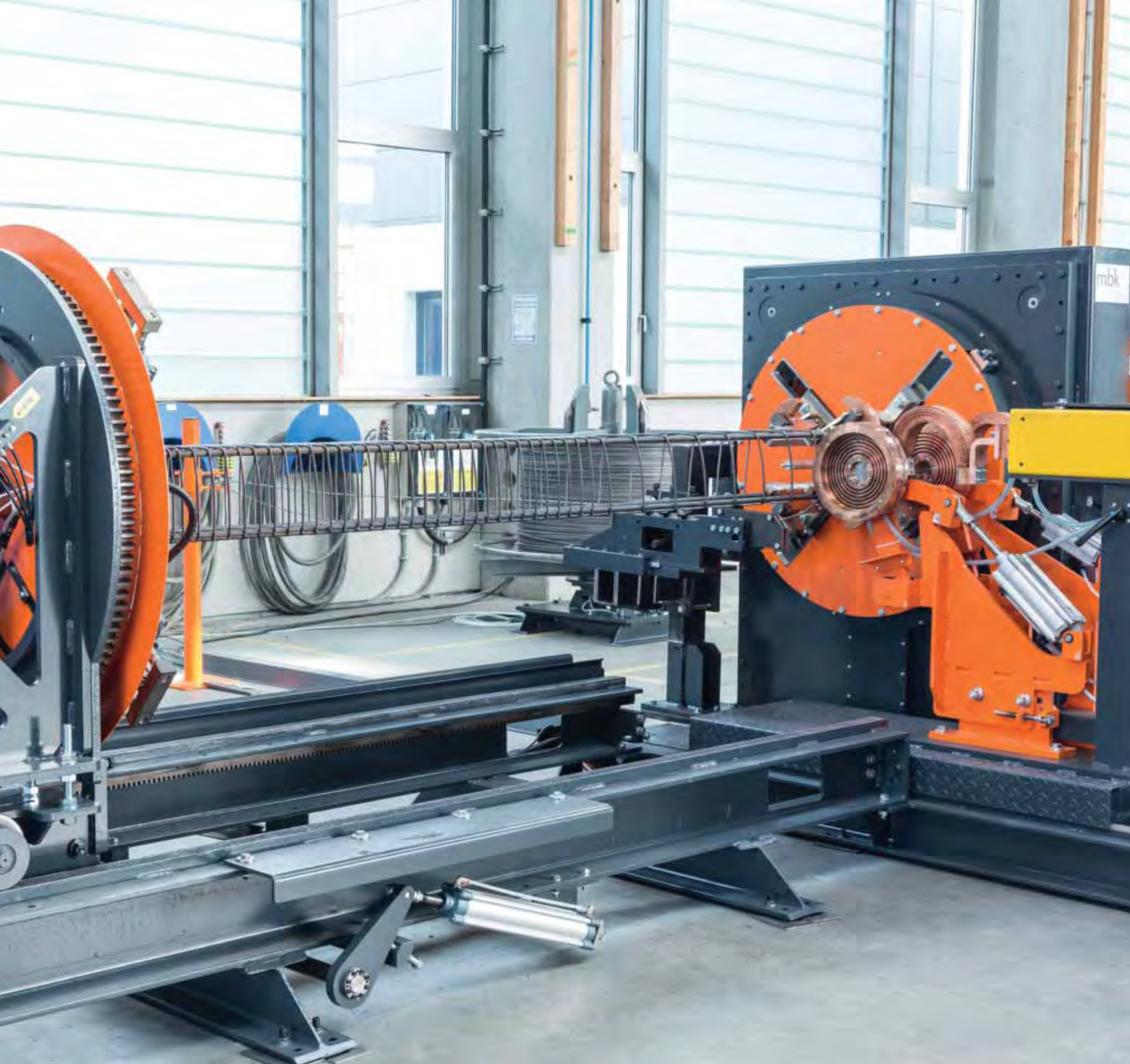

### CHARACTERISTICS AND ACCESSORIES

- No consumption of welding gas and electrodes
- Manual setting of the diameter
- Easy to use (no PC knowledge necessary)
- Highest variability of the wrap wire spacing (production of several short cages in one long cage is fully programmable)
- Setting of cages and welding parameters with memorized cage programs
- Low operating and maintenance effort
- Production of cages with a spigot (cone) using pre-bent longitudinal wires
- Change system for different cage geometries (round and square; only RSM-S)
- Wrap wire decoilers with and without drive
- Possibility of double wires in the corner
- Pneumatic longitudinal clamping (RSM-V only)
- LAN/WLAN connection

| Size                      | 053   |  |
|---------------------------|---|--|
| Version                   | V *   | S **   |
| Flank length cage (outer) | min. 92 x 92 - 118 x 118 mm<br>max. 396 x 396 - 422 x 422 mm<br>depending on wire combinations  | min. 92 x 92 - 118 x 118 mm<br>max. 396 x 396 - 422 x 422 mm<br>depending on wire combinations |
| Cage diameter (outer)     | min. 130 x 130 - 166 x 166 mm<br>max. 560 x 560 - 596 x 596 mm<br>depending on the number of longitudinal wires and wire combinations |  |
| Number of longitudinals   | 4 (optional double wire in the corner)  | Replacement discs (4/8) (5/10) (6/12)  |
| Cage length               | 3,000 - 18,000 mm (other lengths on request)  |  |
| Longitudinal wire Ø       | Single wire 10 - 20 mm (optional 10 - 25 mm)<br>Double wire 10 - 12 mm (optional 10 - 16 mm)  | Single wire 10 - 20 mm (optional 10 - 25 mm)   |
| Wrap wire Ø               | 5 - 8 mm  | 5 - 8 mm (optional 5 - 10 mm)  |
| Spacing of wrap wire      | 20 - 200 mm   |  |
| Welding capacity          | depending on the version up to 160 kVA  |  |

- further sizes on request

\* Square (single, double wire in corner)

\*\* Round, square (optional double wire in corner for square)



## Cage welding machine

VSM-S

for the production of round and square reinforcement cages for driven and bored piles, columns and beams



### CHARACTERISTICS AND ACCESSORIES

- No consumption of welding gas and electrodes
- Very high production rates
- Change system for different cage geometries (round, triangle, square etc.)
- Highest flexibility due to fast changeover of the machine to other geometries
- Setting of cages and welding parameters with memorized cage programs
- Easy operation by the use of a Touch-Panel and IPC/PLC-control
- Highest variability of the wrap wire spacing (production of several short cages in one long cage is fully programmable)
- Ergonomic handling at the wire and cage side
- Possibility of double wires in the corner or wires on the flank
- Power package for higher welding and production performance
- Spooling machine for re-spooling standard coils to a machine spool
- Versatile automation solutions
- LAN/WLAN connection

#### Size

057

|                           |  |
|---------------------------|--|
| Flank length cage (outer) | min. 94 x 94 - 122 x 122 mm<br>max. 422 x 422 - 450 x 450 mm<br>depending on wire combinations   |
| Cage diameter (outer)     | min. 132 x 132 - 172 x 172 mm<br>max. 596 x 596 - 636 x 636 mm<br>depending on wire combinations |
| Number of longitudinals   | Replacement discs (8/4) (10/5) (12/6)<br>(variable) (core solutions)                             |
| Cage length max.          | 3,000 - 24,000 mm (other lengths on request)   |
| Longitudinal wire Ø       | 8 - 20 mm (optional 8 - 25 mm)   |
| Wrap wire Ø               | 5 - 8 mm   |
| Spacing of wrap wire      | 30 - 200 mm  |
| Welding capacity          | depending on the version up to 250 kVA   |

- further sizes on request



## Cage welding machine

VSM-V

for the production of square reinforcements for driven and bored piles, columns and beams

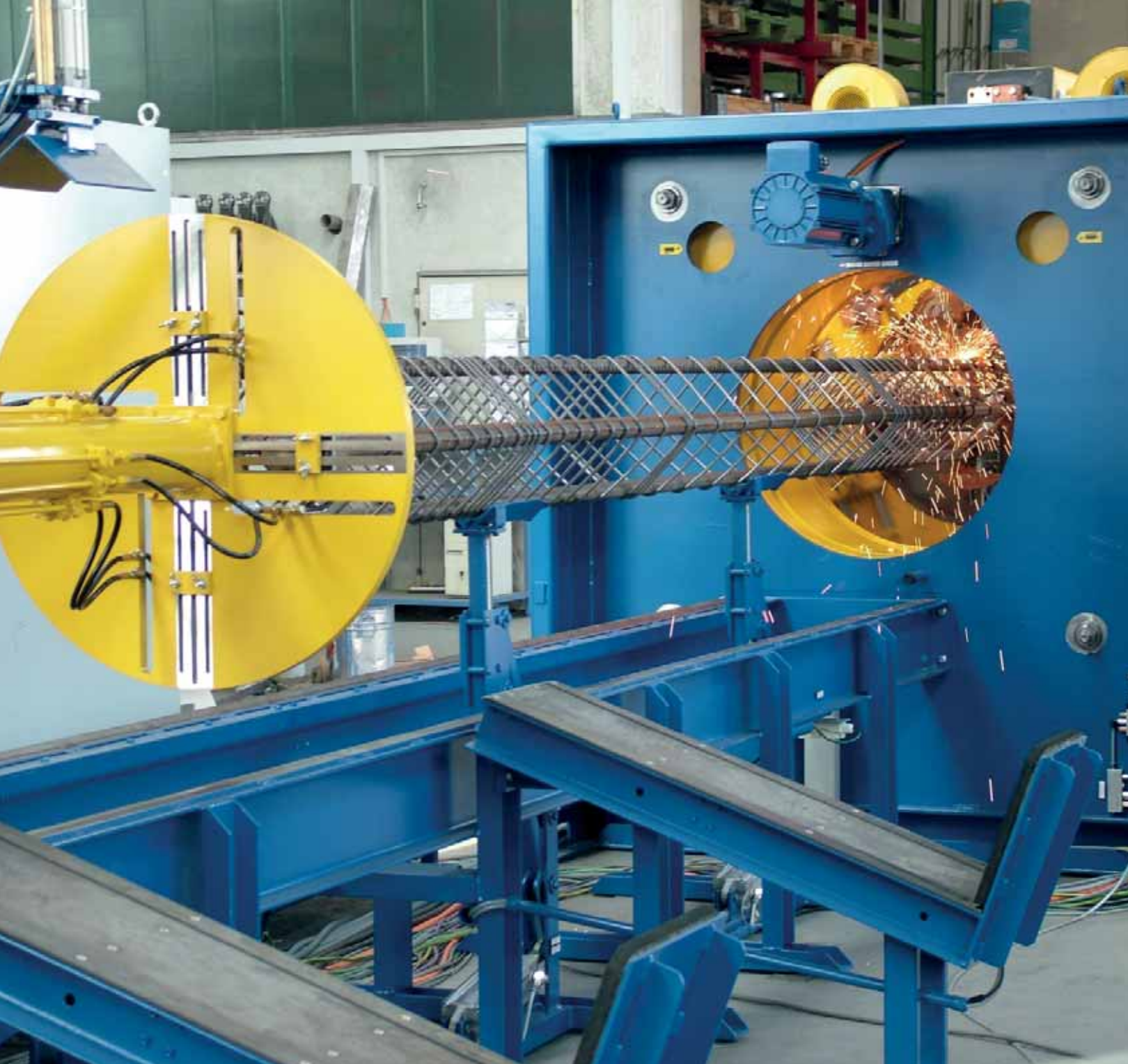

### CHARACTERISTICS AND ACCESSORIES

- No consumption of welding gas and electrodes
- Very high production rates
- Highest flexibility due to fast changeover of the machine
- Setting of cages and welding parameters with memorized cage programs
- Easy operation by the use of a Touch-Panel and IPC/PLC-control
- Highest variability of the wrap wire spacing (production of several short cages in one long cage is fully programmable)
- Ergonomic handling at the wire and cage side
- Possibility of double wires in the corner
- Power package for higher welding and production performance
- Spooling machine for re-spooling standard coils to a machine spool
- Versatile automation solutions
- LAN/WLAN connection

#### Size

053

|                           |  |
|---------------------------|--|
| Flank length cage (outer) | min. 111 x 111 - 139 x 139 mm<br>max. 394 x 394 - 422 x 422 mm<br>depending on wire combinations |
| Number of longitudinals   | 4 (optional double wire in the corner)   |
| Cage length               | 3,000 - 24,000 mm (other lengths on request)   |
| Longitudinal wire Ø       | Single wire 8 - 20 mm (optional 8 - 25 mm)<br>Double wire 8 - 12 mm (optional 8 - 16 mm)         |
| Wrap wire Ø               | 5 - 8 mm   |
| Spacing of wrap wire      | 30 - 200 mm  |
| Welding capacity          | depending on the version up to 250 kVA   |

- further sizes on request



## VSM-Automation

Automation solutions for the cage welding machine type VSM-S and VSM-V from simple automation accessories to fully automatic production lines with buffer solutions.



VSM-S

- Longitudinal wire storage systems for pre-assembling the wires from the coil
- Simplified quick-change system for the product discs
- Automated changing system for the product discs
- Processing station after removal of the reinforcement
- Automatic removal of the finished product for further processing
- Buffer storage system with positioning of the products for removal by crane
- Connection of a multiple wire straightening and cutting system (DRA-M) for pre-assembly of the longitudinal wires



VSM-V

- Connection of a multiple wire straightening and cutting system (DRA-M) for pre-assembly of the longitudinal wires
- Quick adjustment to reduce changeover times when changing the diameter
- Fully automated conversion of all relevant systems to other product sizes
- Integration of a feeding device to allow the welding of a narrow wrap with short longitudinal wire projection
- Chain conveyor as buffer and feeding of the longitudinal wires into the machine (automatic loading also possible via wire straightening and cutting machine DRA)
- Processing station after removal of the reinforcement
- Automatic removal of the finished product for further processing
- Buffer storage system with positioning of the products for removal by crane



## Cage welding machine

ISM

for the production of reinforcement cages for  
the manhole and concrete pipe industry

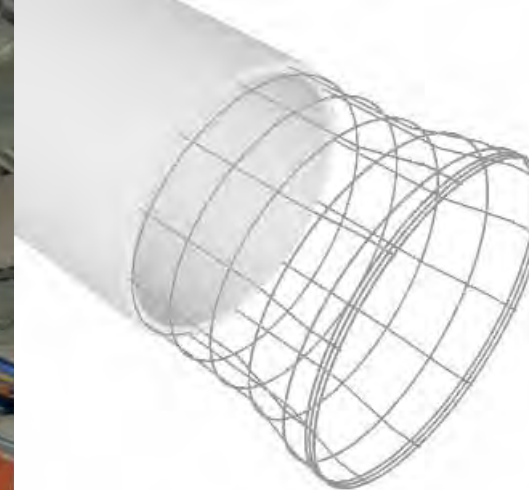

### CHARACTERISTICS AND ACCESSORIES

- Extreme reliability and long life span due to stable construction
- High flexibility
- Dimension change by manual adjustment
- Strictest production tolerances for exact and straight cages; compatible with any standards
- Very low maintenance and energy costs
- Easy to use (no PC knowledge necessary)
- Wrap wire decoilers up to 3 tons
- Switch off ramp with supervision of decoiler
- Wire deflector and wire guiding stands
- Cage removal carriage (standard and electro hydraulically)
- Machine tools

| Size                    | 140   | 190             | 250             | 450            |
|-------------------------|---|-----------------|-----------------|----------------|
| Cage diameter           | 220 - 1,400 mm                              | 220 - 1,900 mm  | 330 - 2,500 mm  | 660 - 4,500 mm |
| Number of longitudinals | <b>12</b>                                   | <b>12/18/24</b> | <b>12/18/24</b> | <b>36/48</b>   |
| Version                 | Round (with bell socket)                    |                 |                 |                |
| Cage length             | 2,000 - 3,000 mm (other lengths on request) |                 |                 |                |
| Longitudinal wire Ø     | 5 - 10 mm                                   |                 |                 |                |
| Wrap wire Ø             | 5 - 12 mm                                   |                 |                 |                |
| Spacing of wrap wire    | 20 - 200 mm                                 |                 |                 |                |
| Welding capacity        | depending on the version up to 125 kVA      |                 |                 |                |

- further sizes on request  
**Bold** Standard



## Cage welding machine

ESM

for the production of reinforcement cages for the manhole and concrete pipe industry

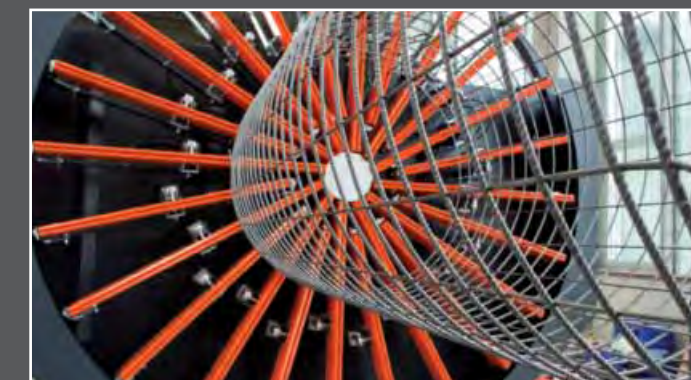
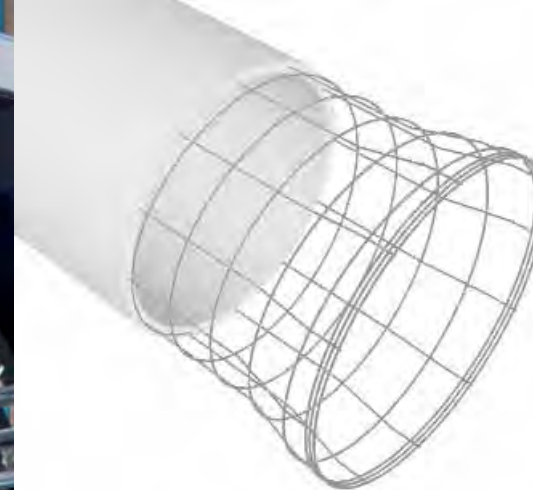
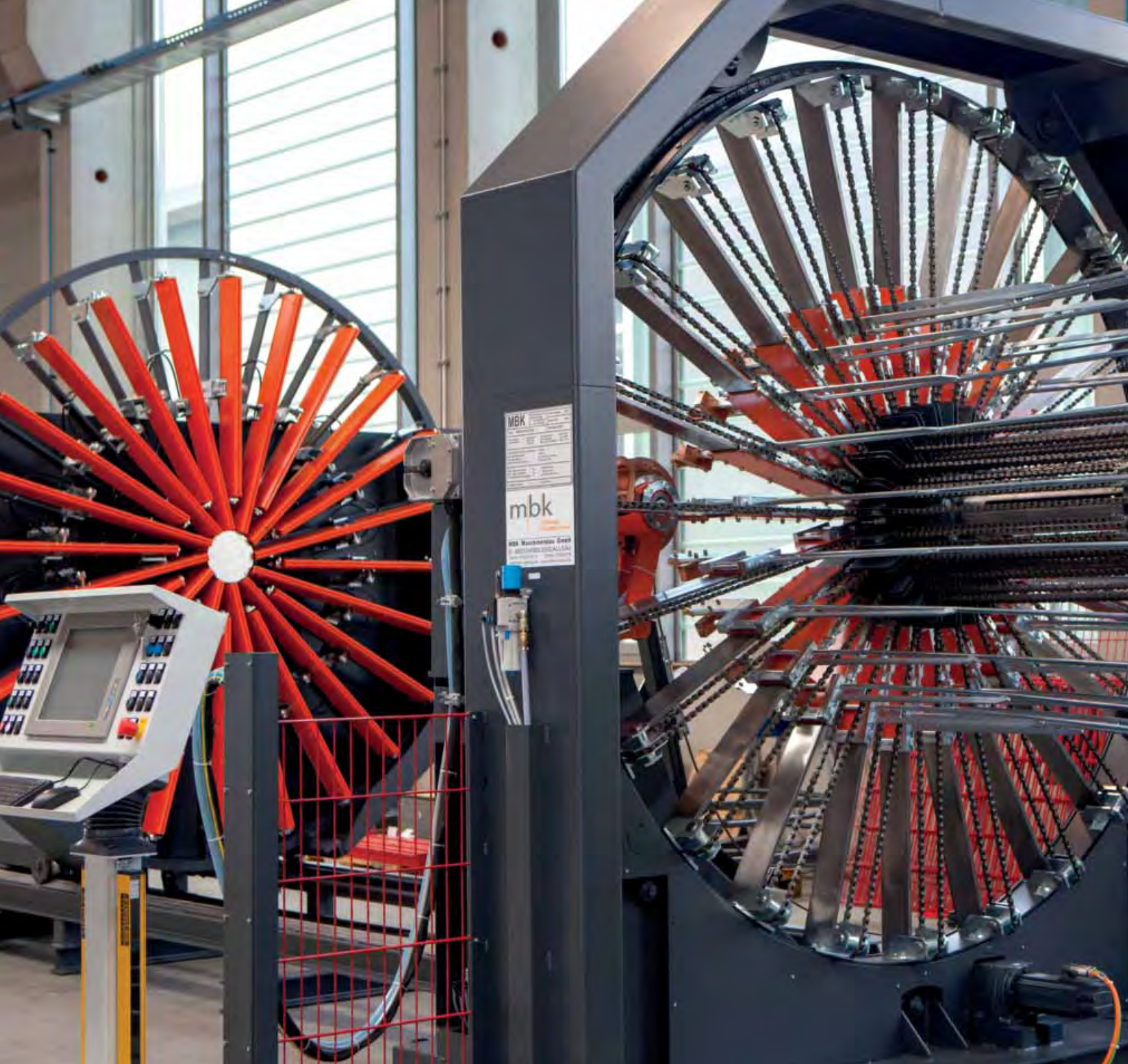

### CHARACTERISTICS AND ACCESSORIES

- Extreme reliability and long life span due to stable construction
- High flexibility
- Dimensional change over by the push of a button and link programs for inner and outer cages
- Strictest production tolerances for exact and straight cages; compatible with any standards
- Very low maintenance and energy costs
- Very user friendly by the use of Touch Panel and IPC/PLC-control
- Wrap wire decoilers with and without drive
- Switch off ramp with supervision of decoiler
- Medium frequency welding (3-phase inverter technology)
- Wire deflector and wire guiding stands
- Cage removal carriage (standard and electro hydraulically)
- Machine tools
- LAN/WLAN connection

| Size                    | 190   | 250            | 300            | 360             |
|-------------------------|---|----------------|----------------|-----------------|
| Cage diameter           | 220 - 1,900 mm  | 330 - 2,500 mm | 330 - 3,000 mm | 330 - 3,600 mm  |
| Number of longitudinals | <b>12/18/24</b>   | <b>18/24</b>   | <b>24/36</b>   | <b>24/36/48</b> |
| Version                 | Round (with bell socket), double cages one behind the other |                |                |                 |
| Cage length             | 2,000 - 5,000 mm (other lengths on request)                 |                |                |                 |
| Longitudinal wire Ø     | 4 - 10 mm (optional 4 - 14 mm)                              |                |                |                 |
| Wrap wire Ø             | 4 - 12 mm   |                |                |                 |
| Spacing of wrap wire    | 20 - 200 mm   |                |                |                 |
| Welding capacity*       | depending on the version up to 125 kVA                      |                |                |                 |

- further sizes on request  
 \* Standard with 2 Phase thyristor control  
**Bold** Standard



## Cage welding machine

**BSM**

for the production of reinforcement cages for the manhole and concrete pipe industry

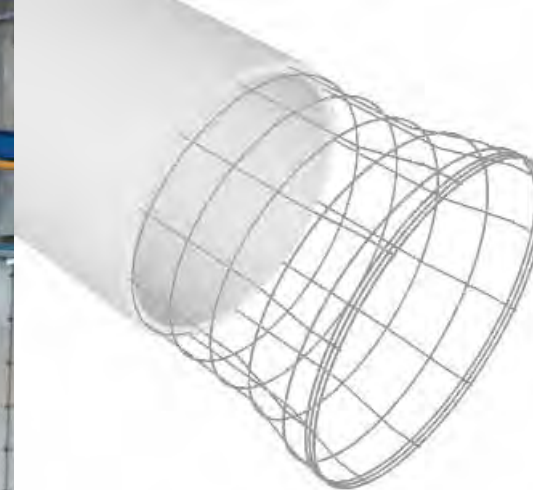
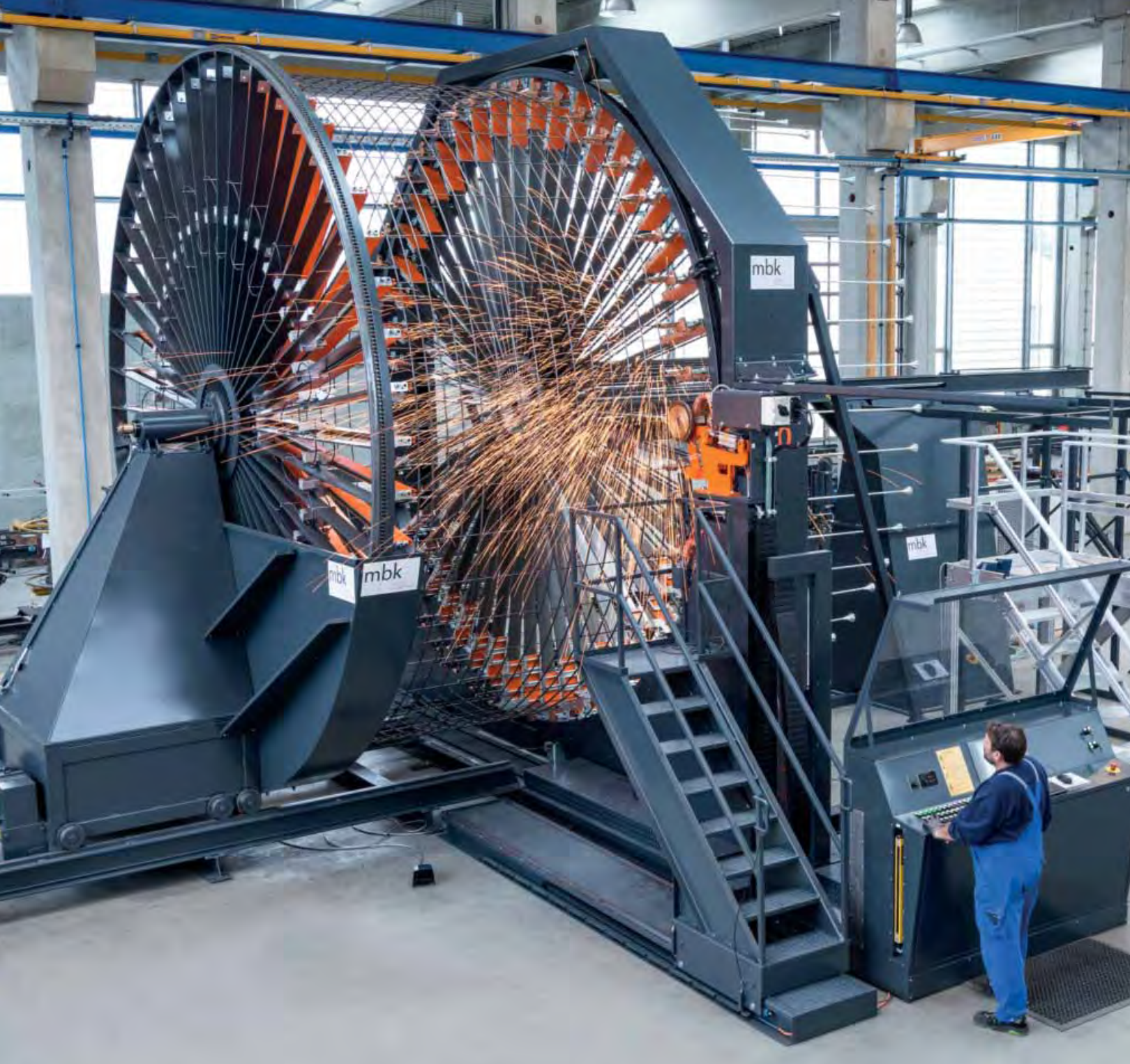

### CHARACTERISTICS AND ACCESSORIES

- Extreme reliability and long life span due to stable construction
- High productivity and flexibility, very low maintenance and energy costs
- Dimensional change over by the push of a button and link programs for inner and outer cages
- Strictest production tolerances for exact and straight cages; compatible with any standards
- Very user friendly by the use of Touch Panel and IPC/PLC-control
- Wrap wire decoilers with and without drive, double winding wire feed, production of conical cages
- Medium frequency welding (3-phase inverter technology)
- Upgrade packages for high welding and high speed capacity
- Wrap wire cutters in different styles (electrical, hydraulically and automated)
- Manual and hydraulic cage removal trolleys
- Versatile automation solutions
- LAN/WLAN connection

| Größe                   | 140   | 190             | 250          | 300          | 360             | 400          | 450          | 520             |
|-------------------------|---|-----------------|--------------|--------------|-----------------|--------------|--------------|-----------------|
| Cage diameter (mm)      | 220 - 1,400   | 220 - 1,900     | 330 - 2,500  | 330 - 3,000  | 330 - 3,600     | 660 - 4,000  | 660 - 4,500  | 900 - 5,200     |
| Number of longitudinals | <b>12</b>   | <b>12/18/24</b> | <b>18/24</b> | <b>24/36</b> | <b>24/36/48</b> | <b>36/48</b> | <b>36/48</b> | <b>36/48/60</b> |
| Version                 | <b>Round</b> (with bell socket), double cages one behind the other<br><b>Oval</b> (round (with bell socket), oval, egg shape, open shape, special shapes) |                 |              |              |                 |              |              |                 |
| Cage length             | 2,000 - 7,000 mm (other lengths on request)   |                 |              |              |                 |              |              |                 |
| Longitudinal wire Ø     | 4 - 10 mm (optional 4 - 14 mm)  |                 |              |              |                 |              |              |                 |
| Wrap wire Ø             | 4 - 12 mm (optional 4 - 16 mm)  |                 |              |              |                 |              |              |                 |
| Spacing of wrap wire    | 20 - 200 mm   |                 |              |              |                 |              |              |                 |
| Welding capacity*       | depending on the version up to 125 kVA  |                 |              |              |                 |              |              |                 |

- further sizes on request  
\* Standard with 2 Phase thyristor control  
**Bold** Standard



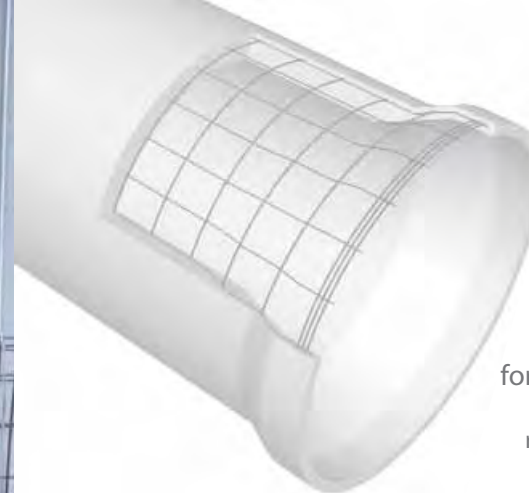

# Cage welding machine

**BSM-ROR**

for the production of reinforcement cages for the manhole and concrete pipe industry  
Reinforcement production in round-oval-round (**patented**) whereby the optimization of the reinforcement cage can mean a **savings potential of up to 50%** for reinforcement and operation

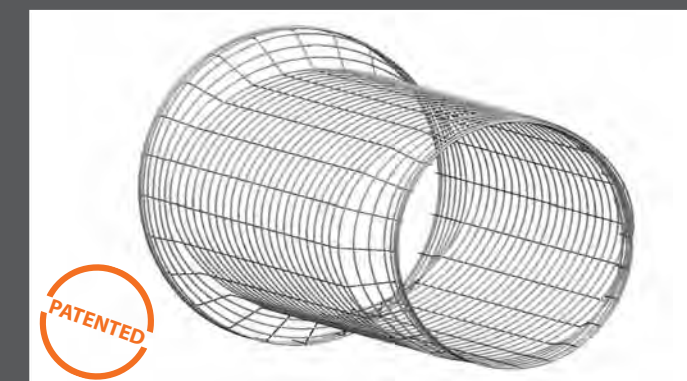
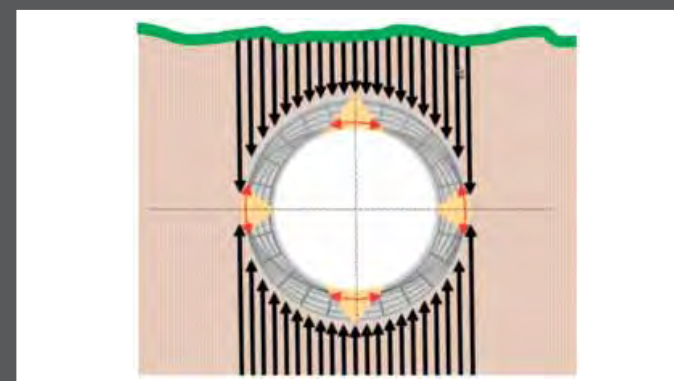

## CHARACTERISTICS AND ACCESSORIES

- The round-oval-round reinforcement can replace a double reinforcement in the concrete pipe
- Extreme reliability and long life span due to stable construction
- High productivity and flexibility, very low maintenance and energy costs
- Dimensional change over by the push of a button and link programs for inner and outer cages
- Strictest production tolerances for exact and straight cages; compatible with any standards
- Very user friendly by the use of Touch Panel and IPC/PLC-control
- Wrap wire decoilers with and without drive, double winding wire feed, production of conical cages
- Medium frequency welding (3-phase inverter technology)
- Upgrade packages for high welding and high speed capacity
- Wrap wire cutters in different styles (electrical, hydraulically and automated)
- Manual and hydraulic cage removal trolleys
- Versatile automation solutions
- LAN/WLAN connection

Supported by:  
Federal Ministry  
for Economic Affairs  
and Energy  
on the basis of a decision  
by the German Bundestag



| Size                     | 190  | 250             | 300            |
|--------------------------|--|-----------------|----------------|
| Cage diameter            | 220 - 1,900 mm   | 330 - 2,500 mm  | 330 - 3,000 mm |
| Number of longitudinals* | <b>12/18/24</b>  | <b>12/18/24</b> | <b>24/36</b>   |
| Version                  | <b>Round (with bell socket)</b><br><b>Oval (round (with bell socket), oval, egg shape, open shape, special shapes)</b> |                 |                |
| Cage length              | 2,000 - 3,000 mm (other lengths on request)  |                 |                |
| Longitudinal wire Ø      | 4 - 10 mm  |                 |                |
| Wrap wire Ø              | 4 - 12 mm  |                 |                |
| Spacing of wrap wire     | 20 - 200 mm  |                 |                |
| Welding capacity*        | depending on the version up to 125 kVA   |                 |                |

- further sizes on request  
\* Standard with 2 Phase thyristor control  
**Bold** Standard



## BSM-Automation

Automation solutions for cage welding machine type BSM and BSM-ROR from simple automation accessories to fully automatic production lines with buffer solutions and transfer of the reinforcement to the pipe machine



### CHARACTERISTICS AND ACCESSORIES

- Motorized wrap wire decoilers
- Automated longitudinal wire feeding for pre-cut wires from bundle
- Wire straightening and cutting units for the production and automated longitudinal wire feeding from coil
- Automated wrap wire changeover
- Automated wrap wire cutter
- Cage removal robots for the automated removal and handling of the cages
- Cage removal and assembly devices for the automated removal, handling and assembly of double cages
- Buffer solutions for the storage of reinforcements
- Transport solutions for transferring the reinforcement cages to the pipe machine

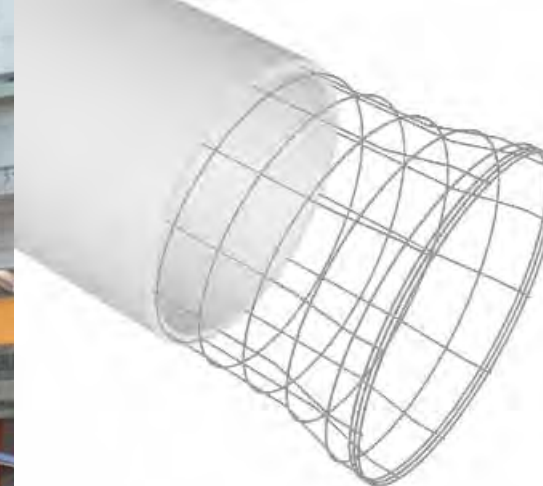

### CHARACTERISTICS AND ACCESSORIES

- Various software solutions such as:
  - Machine software for connection to the office
  - Production lists and reports generated and sent to the office
  - Logging of all machine parameters and settings
  - Logging and saving of production data
  - Customer requirements



## AFTER-SALES SERVICE RETROFIT



### SERVICE / MAINTENANCE CONTRACT

We take your wishes seriously and want you to feel that you are in good hands. Our competent customer service is also available to you after your machines have been commissioned.

Whether it's regular maintenance, our wide range of services or quick repairs to avoid downtimes: our online help service, our service team and our worldwide network of competent service support locations are not only available by telephone, but can also be quickly on site to maintain your machine in top condition.

Many mbk customers are already impressed by the advantages of concluding a service-/maintenance contract when purchasing a machine.

- High availability and high productivity of your machine
- More profit through consistently high production output
- Simple cost accounting - easy to calculate additional costs due to regular maintenance
- Savings through discounts on original spare parts and hourly rates

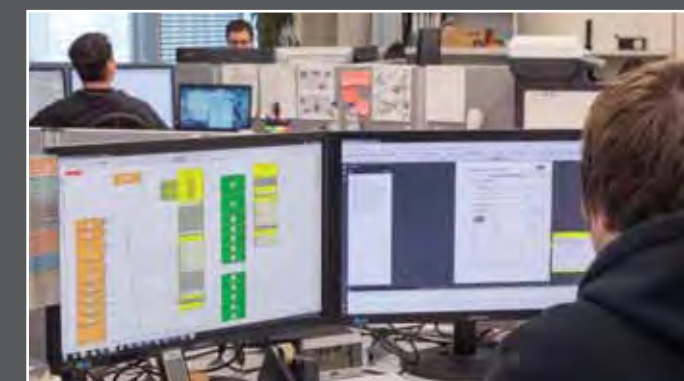

### RETROFIT

- Modernization of older generations of mbk machines to ensure operational readiness and reduce operating costs (various expansion stages possible)
- Conversion options for adapting operational purposes, extending the areas of application and increasing production capacity
- Retrofitting of safety concepts according to the latest state of the art

If you want to upgrade your old machine to a new working level or want to automate your workflow in order to ensure production reliability for the future, please contact us. We can provide an individual solution for each and every customer.

### AFTER-SALES SERVICE

- Trained and highly motivated service personnel are available worldwide for the assembly and commissioning as well as maintenance and repair of the machines
- Spare and wear parts are available worldwide in the shortest possible time through decentralized support locations
- Cost saving because of exchange parts program
- Good coverage of all time zones
- LAN/WLAN connection of the machines (remote maintenance/tele-service), updates and production planning possible
- Training of customers in the use, adjustment and handling of machines
- Online training courses and online help from service staff directly to the machine operator
- Online help portal via the homepage



## ACCESSORIES



### Coil grippers

Fast and safe coil change is an important component for smooth production. Simple and quick coil changes are possible with mbk coil grippers for different diameters which have been specially adapted to our wrap wire decoilers. The automatic fixing and disengagement in the coil makes this possible.

### Butt welding machines

When a wire coil comes to its end, the wire ends of the empty coil and the full wire coil can be welded together using a butt welding machine. A time-consuming threading of the new wire into the machine is not necessary.

### Safety accessories / safety fence packages

A comprehensive protection concept consisting, for example, of a safety fence with or without doors, safety light barriers, etc. is included as standard in every scope of delivery. We can offer you special security packages for special applications and adaptations to your company layout.

### Wire cutters of various types (electric, hydraulic and automatic)

We can supply wire cutters for different wire diameters depending on the application and type of energy.

### Mesh bending and mesh cutting machines

Practical bending machines for all types of applications and highest performance requirements as well as mesh cutting machines tailored to your requirements for fast and economical processing of structural steel mesh.

### Stirrup bending machines

For simple, fast and fully automatic production of all types of polygonal stirrups, rings and spirals from coil made of both hot-rolled and cold-drawn material.

Machinery and equipment encompassing the handling and processing of reinforcing steel.

and much, much more ...





**mbk**  
STRONG  
CONNECTIONS

**mbk Maschinenbau GmbH**  
Friedrich-List-Str. 19  
88353 Kisslegg / Germany

Tel. +49 7563 9131 0  
Fax +49 7563 2566  
info@mbk-kisslegg.de



[www.mbk-kisslegg.de](http://www.mbk-kisslegg.de)

Visit our social media channels!